

INJECTION HOSES CONSTRUCTION CHEMISTRY



**MASTERTUBE
YELLOW**
injection hose system
pages 100 – 103



**MASTERTUBE
RED/YELLOW**
injection hose system
pages 100 – 103



**PROTECT resin system
+ Universal concrete adhesive
+ Injection packers**
pages 104 – 106



**LIDOL concrete release agent
in MULTI and BIO quality**
pages 107 – 108

MASTERTUBE injection hose systems



Injection hoses

Art.Gr. 300

Art. no.	Description	PU	Secondary packaging	Weight	Price/m
030400	MASTERTUBE YELLOW round, size: 6/12 mm, PVC injection hose	1 roll of 100 m	1 pallet = 48 rolls	10.25 kg per roll	€7.20
030050	MASTERTUBE RED/YELLOW round, size: 6/12 mm, red/yellow Injection hose with woven jacket	1 roll of 100 m	1 pallet = 48 rolls	10.35 kg per roll	€8.00

- Very high-pressure water test
- For injection with polyurethane resin
- For multiple injection with acrylate
- Hose sections up to 15 m with polyurethane resin



Art. no. 030400



Art. no. 030050

The MASTERTUBE YELLOW injection hose has fastening marks at intervals of 15 cm.

MASTERTUBE YELLOW installation set

Art.Gr. 301

Art. no.	Description	PU	Weight/set	Price/set
030055	MASTERTUBE YELLOW installation set 10 m MASTERTUBE YELLOW injection hose 100 plastic fastening clips, type B 2 fastening packers (1 x red, 1 x white), including 2 nipples 2 hose connectors	1 carton = 1 set	1.60 kg	€82.00

MASTERTUBE RED/YELLOW installation set

Art.Gr. 301

Art. no.	Description	PU	Weight/set	Price/set
030052	MASTERTUBE RED/YELLOW installation set 40 m MASTERTUBE RED/YELLOW injection hose 20 fastening packers, including nipples 300 plastic fastening clips, type B 10 hose connectors 1 roll of filament tape	1 carton = 1 set	6.10 kg	€390.00



Art. no. 030055















Art. no. 030052

Injection hose and accessories

Art.Gr.
302

Art. no.	Description	PU	Secondary packaging	Weight per pc.	Price per pc.	
030060	Fastening packer, without nipple, for fastening of injection hose to the formwork, Colour of packer: black, 10 red plugs, 10 white plugs, for resin injection	1 bag of 20 pcs.	1 carton = 25 bags	0.50 kg per bag	€4.70	
030063	Nipples for fastening packers	1 bag of 20 pcs.		0.10 kg per bag	€0.85	
030362	Plastic foam for fastening packer Diameter 35 mm, Thickness 20 mm, self-adhesive, 10 pcs. white, 10 pcs. anthracite	1 bag of 20 pcs.		0.04 kg per bag	€0.65	
030065	Fixing spider for fixing the fastening packer to the reinforcement	1 pc.		0.08 kg	€10.15	
030075	Plastic fastening clip type A to be pressed into the fresh concrete, distance between clips: 15 cm	1 bag of 100 pcs.	1 sack = 25 bags	0.29 kg per bag	€25.90 per 100 pcs.	
030070	Plastic fastening clip type B for pressing into the fresh concrete or into Ø 8 mm bore holes, distance between clips: 15 cm	1 bag of 100 pcs.	1 sack = 25 bags	0.29 kg per bag	€23.60 per 100 pcs.	
030080	Metal clip with pre-fitted nail for all common nailguns, for firing and nailing, distance between clips: 15 cm	1 carton of 100 pcs.		1.75 kg per carton	€0.85	
030081	Metal clip without nail	1 carton of 100 pcs.		1.40 kg per carton	€0.35	
030083	Nail plug 5 x 40 mm borehole Ø 5 mm	1 carton of 200 pcs.		0.63 kg per carton	€10.40 per 100 pcs.	
030072	Fastening grid for MASTERTUBE 1 carton = 25 m (25 grids of 1 m)	1 carton		1.65 kg per carton	€2.60 per m	
030082	MASTERTUBE joint sheet metal clamp	1 bag of 100 pcs.		0.60 kg per bag	€50.00 per 100 pcs.	

Injection hose and accessories

Art. no.	Description	PU	Weight per pc.	Price per pc.	
030100	Hose connector for hose extension and connection of odd-ments	1 bag of 10 pcs.	0.03 kg per bag	€2.20	
030102 030104	Ventilation hose Fabric hose blue-transparent round, size: 5/11 mm red-transparent round, size 5/11 mm	1 roll of 50 m	5.50 kg 5.50 kg per roll	€3.20/m €3.20/m	
030112	Injection end pieces including sealing plug and hose connector, length 50 cm blue-transparent round 5/11 mm	1 bundle of 10 pcs.	0.60 kg per bundle	€7.35	
030114	red-transparent round 5/11 mm	1 bundle of 10 pcs.	0.60 kg per bundle	€7.35	
030096	Sealing plugs for injection end pieces and ventilation hose	1 bag of 20 pcs.	0.01 kg per bag	€0.65	
030350	Storage box for ventilation hose	1 bag of 10 pcs.	0.73 kg per bag	€6.00	
030140	Hand-lever press 500 ccm for resin injection	1 pc.	1.05 kg	€38.00	
030150	Reinforced hose L 300 mm incl. gripping head	1 pc.	0.09 kg	€17.25	
030160	Gripping head	1 pc.	0.03 kg	€7.40	
030165	Manometer 400 bar with T piece incl. connecting tube and adapter	1 pc.	0.28 kg	€91.00	
030130	Injection packer, including nipple for injection via ventilation hose or injection hose	1 bag of 10 pcs.	0.13 kg per bag	€5.60	
030090	Filament tape roll width: 25 mm, roll length: 50 m to safeguard the hose ends	1 carton of 36 rolls	0.22 kg per roll	€6.90 per roll	

MASTERTUBE injection hose systems



Two systems with 100% reliability

The MASTERTUBE YELLOW and MASTERTUBE RED/YELLOW injection hoses make construction joints watertight. The form and structure of the hose profiles ensure a particularly secure and even filling of shrinkage gaps and damaged spots.



Both systems are also available as an installation set.

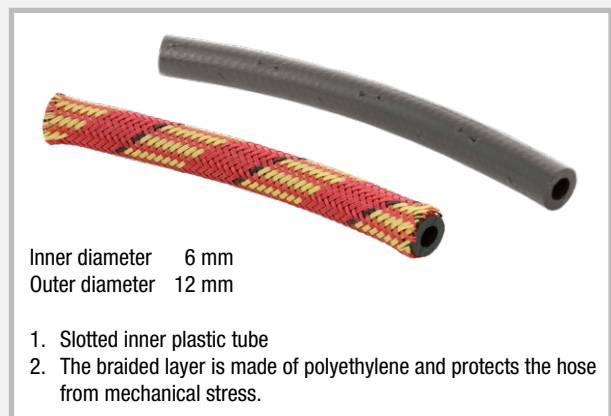
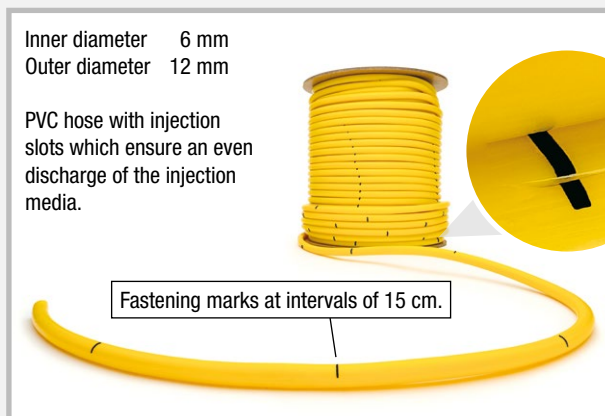

	MASTERTUBE YELLOW	MASTERTUBE RED/YELLOW
Very high water pressure tests	50 m water column	50 m water column
For injection with polyurethane resin	tested	tested
For multiple injection with acrylate	tested	tested
Grouting circuits up to 15 m	tested	tested
Even discharge of injection material	tested	tested
No sintering during concreting	tested	tested
Suitable for zones with frequently varying water levels	tested	tested
All-weather installation	-10°C to + 60°C	-10°C to + 60°C
Extremely straightforward installation	Used on building sites for more than 10 years	Used on building sites for more than 20 years
Accessories	Comprehensive system	Comprehensive system



PROTECT resin system

Injection resins, adhesives and cleaning agents for injection of injection hoses and injection packers and pressure water-tight bonding of fibre cement plugs.

Universal concrete adhesive

PROTECT Easy 1K



Single-component polymer-based concrete adhesive

For water-tight bonding of all fibre cement distance tubes and for the bonding of split FASO lining pipes.

Processing takes approx. 20 min. at +23°C;

Resistant to all normal uncontaminated groundwater.

Art.Gr. 308

Art. no.	Description	PU	Secondary packaging	Weight/aluminium bag	Price
040030	PROTECT Easy 1K in aluminium bag 800 g	1 aluminium bag	1 carton = 20 aluminium bags	0.80 kg	€20.00 per aluminium bag €25.00/kg

PROTECT BK 2K



Solvent-free epoxy-based concrete adhesive

For water-impermeable bonding of all fibre cement distance tubes, for non-positive connection of concrete components and for the bonding of split FASO lining pipes.

Processing time approx. 60 min. at +20°C

Resistances of PROTECT BK once cured:

Diluted acids, mineral oil, lubricants and fuels, salt water, waste water, large number of alkalis and solvents, approved for use in contact with drinking water



Art.Gr. 308

Art. no.	Description	PU	Secondary packaging	Weight	Price/kg
040100	PROTECT BK 2K for pressure water-tight sealing of fibre cement distance tubes.	1 kg combination can: (0.5 kg component A + 0.5 kg component B)	1 carton = 10 combination cans 1 pallet = 28 cartons	1.20 kg per can	€26.00

PROTECT Clean

Cleaning agent

For cleaning of polyurethane and epoxy resin prior to curing.



Art.Gr. 303

Art. no.	Description	PU	Secondary packaging	Weight	Price/l
040045	PROTECT Clean	1 can 1 l	1 carton = 12 cans	0.96 kg/can	€13.30
040040	PROTECT Clean	1 canister 10 l	1 canister	9.45 kg/canister	€11.00

NEW! MC-Injekt 2300 flow

Polyurethane resin for hose and crack injection

Permanently sealing, moisture-reactive injection resin;
CE marking;
Processing time up to 100 minutes at +20°C;



Art.Gr.
303

Art. no.	Description	PU	Secondary packaging	Weight	Price/l
040015	MC-Injekt 2300 flow polyurethane resin	1 l combination can: (0.5 l component A + 0.5 l component B)	1 carton = 6 cans	1.30 kg per can	€28.00

Application

All resins must be very well homogenised during mixing.
Example MC-Injekt 2300 flow:

Installation instructions, technical data and data sheets can be found on our website:
www.mastertec.eu

Resins and adhesives cannot be shipped at temperatures below +5°C.



1 Processing materials: Protective gloves, safety goggles, cordless screwdriver, suitable mixer.



2 Pour the entire contents of hardener component A into the combination can of component B.

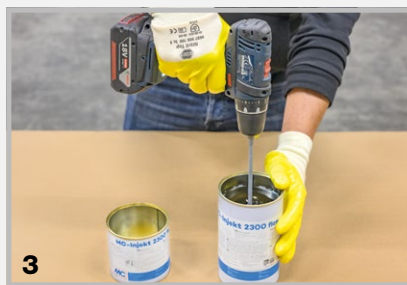

3 Stir the mixture for at least 2 minutes.



4 Transfer the mixed material into a clean, dust-free container for further processing, either by machine or manually.

MC-Injekt 1264 compact

Epoxy resin

Non-positive filling of cracks and joints;
Injection into injection hoses;
Suitable for dry and damp substructures;
Processing time approx. 25 min. at +20°C;



Art.Gr.
303

Art. no.	Description	PU	Secondary packaging	Weight	Price/l
040020	MC-Injekt 1264 compact epoxy resin	1 l combination can: (800 ml component A + 200 ml component B)	1 carton = 6 cans	1.35 kg per can	€33.50

MC-Injekt 2133

Single-component, fast-foaming polyurethane-based foam resin

Immediately stops the inflow of water; rapid expansion with high increase in volume;
Reaction time upon contact with water approx. 10-15 seconds;



Art.Gr.
303

Art. no.	Description	PU	Secondary packaging	Weight	Price/l
040050	MC-Injekt 2133 foam resin	1 l can	1 carton = 6 cans	1.30 kg per can	€35.00

Injection packers / surface packers

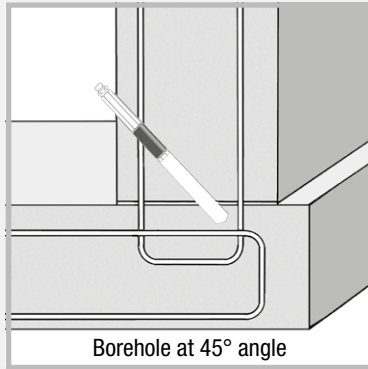
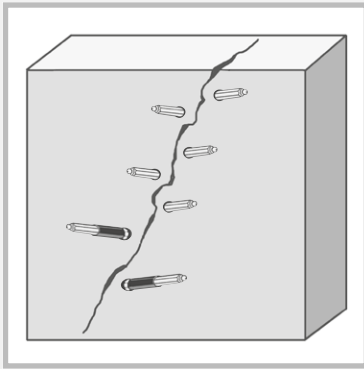

Art. no.	Screw injection packer including nipple / size	Drill bit Ø	PU	Weight per carton	Price per pc.
030185	10/70 mm	10 mm	1 carton of 100 pcs.	1.90 kg	€2.25
030187	10/100 mm	10 mm	1 carton of 100 pcs.	2.70 kg	€2.35
030183	13/80 mm	14 mm	1 carton of 100 pcs.	2.90 kg	€2.40
030180	13/100 mm	14 mm	1 carton of 100 pcs.	4.65 kg	€2.45
030181	13/170 mm	14 mm	1 carton of 100 pcs.	7.60 kg	€4.00
030182	13/250 mm	14 mm	1 carton of 100 pcs.	10.80 kg	€7.00

One day site packer

Art.Gr. 304

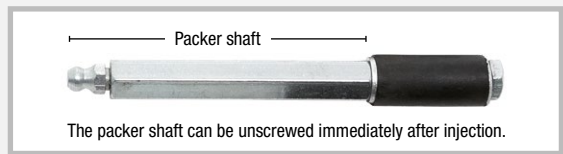

Art. no.	One day site packer including nipple / size	Drill bit Ø	PU	Weight per carton	Price per pc.
030188	10/110 mm	10 mm	1 carton of 100 pcs.	4.00 kg	€3.15
030189	13/115 mm	14 mm	1 carton of 100 pcs.	4.60 kg	€3.90

Surface packer

Art.Gr. 304

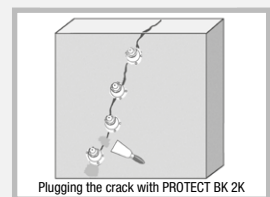

Art. no.	Description	PU	Weight	Price/pc.
030200	Plastic surface packers, washer diameter 5 cm	1 bag of 100 pcs.	1.70 kg per bag	€4.00

Plastic injector

Art.Gr. 304

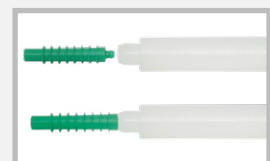
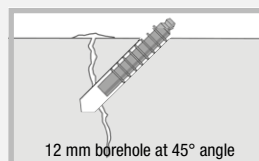
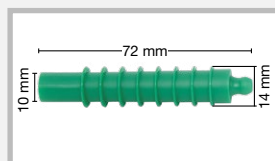



Art. no.	Description	PU	Weight	Price/pc.
030210	Plastic injector with non-return ball	1 bag of 200 pcs.	0.80 kg per bag	€0.95
030215	Impact stud	1 pc.	0.07 kg/pc.	€9.90

1 HYDROPHILIC WATERSTOPS
2 JOINT SHEET METALS
3 INJECTION HOSES CONSTRUCTION CHEMISTRY
4 SERVICE DUCTS
5 LIGHTNING PROTECTION
6 FORMWORK ACCESSORIES

LIDOL concrete release agent

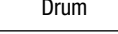
Art.Gr.
305

Art. no.	Description	PU	Secondary packaging	Weight	Price	
040310	LIDOL MULTI Universal release agent for all common types of formwork	1 canister 25 l	1 pallet = 24 canisters	23.4 kg per canister	€4.90/l	
040320	LIDOL MULTI	1 drum 200 l with integrated faucet	1 pallet = 2 drums	184.6 kg per drum	€4.70/l	 Drum
040330	LIDOL BIO Universal release agent for all common types of formwork Rapidly biodegradable Environmental label "Blue Angel"	1 canister 25 l	1 pallet = 24 canisters	23.4 kg per canister	€7.30/l	 25 l canister

LIDOL MULTI

LIDOL MULTI is an environmentally sound universal release agent

The application of LIDOL MULTI to the formwork prevents the formwork from coming into contact with the concrete.

The formwork can therefore be easily stripped.

Applications:

- For all common formwork types
- With fair-faced concrete
- When coating concrete surfaces with plaster, stucco or similar material, e.g. wallpaper, paint, ceramic
- Does not contain corrosion protection additives, corrosion protection is provided by mineral oils



Environmental aspects:

- Water hazard class 1 = low hazard to water
- Not subject to mandatory labelling
- Flashpoint > +120°C
- Neutral odour

Application:

LIDOL MULTI is not sensitive to frost and can be used without problems in all weather conditions. The release agent can be applied by spraying, brushing or rolling. The most economical application method is using a compression sprayer.

LIDOL BIO

LIDOL BIO is an environmentally sound and highly biodegradable universal release agent

Special award:

Due to its high environmental compatibility, LIDOL BIO was awarded the environmental label “Blue Angel” by RAL Deutsches Institut für Gütesicherung und Kennzeichnung e.V (German Institute for Quality Assurance and Labelling).



Applications:

- In water protection areas and zones with environmental stipulations
- For all common formwork types
- With fair-faced concrete
- When coating concrete surfaces with plaster, stucco or similar material, e.g. wallpaper, paint, ceramic



Environmental aspects:

- Water hazard class 1 = low hazard to water, highly biodegradable
- Not subject to mandatory labelling
- Flashpoint > +120°C
- Neutral odour



Application:

LIDOL BIO is not sensitive to frost and can be used without problems in all weather conditions. The release agent can be applied by spraying, brushing or rolling. The most economical application method is using a compression sprayer.

Types of formwork	Yield per 1 litre of LIDOL BIO	Yield per 1 litre of LIDOL MULTI
formwork panels	approx. 75 m ²	approx. 80 m ²
planned timber surface	approx. 35 m ²	approx. 40 m ²
unplanned timber surface	approx. 25 m ²	approx. 30 m ²