

LIGHTNING PROTECTION



Earth conductors
pages 154 – 155



Connectors
pages 156 – 161



Fixed earthing terminals, wall bushings + accessories
pages 162 – 173

Earth conductors

Dimensions and materials according to DIN EN 62561-2

Earthing straps

Galvanised steel

Art.Gr.
500

Art. no.	Size	Material	PU	Secondary packaging	Price
100014	30 x 3.5 mm	Galvanised steel Z 500	1 roll of 25 kg = approx. 30 m	1 pallet = 40 rolls	Current price available on request
100016	30 x 3.5 mm	Galvanised steel Z 500	1 roll of 50 kg = approx. 60 m	1 pallet = 20 rolls	Current price available on request
100022	40 x 4.0 mm	Galvanised steel Z 500	1 roll of 50 kg = approx. 39 m	1 pallet = 20 rolls	Current price available on request
100024	40 x 5.0 mm	Galvanised steel Z 500	1 roll of 50 kg = approx. 32 m	1 pallet = 20 rolls	Current price available on request

Stainless steel

Art. no.	Size	Material	PU	Secondary packaging	Price
100028	30 x 3.5 mm <small>Art.Gr. 502</small>	V2A stainless steel according to DIN EN 62561-2	1 roll of 25 kg = approx. 30 m	1 pallet = 40 rolls	Current price available on request
100031	30 x 3.5 mm <small>Art.Gr. 501</small>	V4A stainless steel according to DIN EN 62561-2	1 roll of 25 kg = approx. 30 m	1 pallet = 40 rolls	Current price available on request
100032	30 x 3.5 mm <small>Art.Gr. 501</small>	V4A stainless steel according to DIN EN 62561-2	1 roll of 50 kg = approx. 60 m	1 pallet = 20 rolls	Current price available on request
100035	40 x 4.0 mm <small>Art.Gr. 501</small>	V4A stainless steel according to DIN EN 62561-2	1 roll of 50 kg = approx. 39 m	1 pallet = 20 rolls	Current price available on request

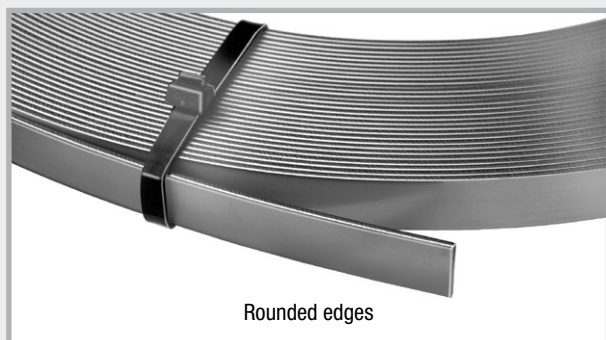
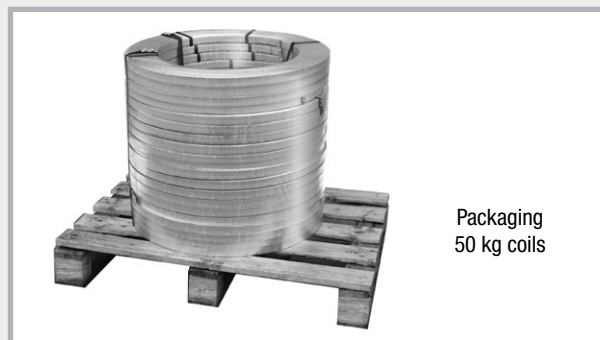

Round wires



Single coil, galvanised

Single coil
Stainless steel standardSingle coil
Stainless steel SUPER-SOFTSingle coil
Aluminium round wire

Galvanised steel

Art.Gr.
505

Art. no.	Size	Material	PU	Secondary packaging	Price
100041	Ø 10 mm	Galvanised steel Z 350	1 roll of 25 kg = approx. 40.5 m	1 pallet = 40 rolls	Current price available on request
100042	Ø 10 mm	Galvanised steel Z 350	1 roll of 50 kg = approx. 81 m	1 pallet = 20 rolls	Current price available on request

Stainless steel standard

Art. no.	Size	Material	PU	Secondary packaging	Price
100051	Ø 10 mm <small>Art.Gr. 507</small>	V2A stainless steel according to DIN EN 62561-2	1 roll of 25 kg = approx. 40.5 m	1 pallet = 20 rolls	Current price available on request
100055	Ø 10 mm <small>Art.Gr. 506</small>	V4A stainless steel according to DIN EN 62561-2	1 roll of 25 kg = approx. 40.5 m	1 pallet = 20 rolls	Current price available on request
100056	Ø 10 mm <small>Art.Gr. 506</small>	V4A stainless steel according to DIN EN 62561-2	1 roll of 50 kg = approx. 81 m	1 pallet = 10 rolls	Current price available on request
100062	Ø 10 mm <small>Art.Gr. 506</small>	V4A stainless steel according to DIN EN 62561-2	1 roll of 31 kg = approx. 50 m	1 pallet = 16 rolls	Current price available on request

Stainless steel SUPER-SOFT

A special manufacturing procedure ensures uniformly soft quality of the wire.

SUPER-SOFT can be unrolled very easily and lies flat without undulation.

Art.Gr.
508

Art. no.	Size	Material	PU	Secondary packaging	Price
100061	Ø 10 mm	SUPER-SOFT V4A according to DIN EN 62561-2, inner diameter 900 mm	1 roll of 25 kg = approx. 40.5 m	1 pallet = 40 rolls	Current price available on request

Aluminium

Art.Gr.
509

Art. no.	Size	Material	PU	Secondary packaging	Price
100080	Ø 8 mm	ALU AlMgSi soft-twistable	1 roll of 20 kg = approx. 148 m	1 pallet = 25 rolls	Current price available on request

Multi-purpose connecting clamps

with mushroom head bolt and protection against twisting

Art.Gr.
511



Art. no.	Description	PU	Secondary packaging	Weight per carton	Price per pc.
100147	Galvanised steel , 2-part, round/round, Clamping range: Round conductor Ø 8 + 10 mm, with M10 mushroom head bolt and protection against twisting	1 carton of 50 pcs.	1 pallet = 5600 pcs.	5.05 kg	€1.37
100149	V2A stainless steel , 2-part, round/round Clamping range: Round conductor Ø 8 + 10 mm, with M10 mushroom head bolt and protection against twisting	1 carton of 50 pcs.	1 pallet = 5600 pcs.	4.45 kg	€3.30
100150	V4A stainless steel , 2-part, round/round Clamping range: Round conductor Ø 8 + 10 mm, with M10 mushroom head bolt and protection against twisting	1 carton of 50 pcs.	1 pallet = 5600 pcs.	4.50 kg	€4.30

Multi-purpose connecting clamps

with thread in lower part

Art.Gr.
511

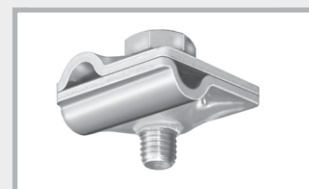

Art. no.	Description	PU	Secondary packaging	Weight per carton	Price per pc.
100157	Galvanised steel , 2-part, round/round, Clamping range: Ø 8 + 10 mm, M10 screw, thread in lower part	1 carton of 50 pcs.	1 pallet = 5600 pcs.	4.45 kg	€1.55
100159	V4A stainless steel, 2-part , round/round Clamping range: Ø 8 + 10 mm, M10 screw, thread in lower part	1 carton of 50 pcs.	1 pallet = 5600 pcs.	3.75 kg	€4.00
100153	Aluminium , 2-part, round/round, Clamping range: Ø 8+ 10 mm, NIRO M10 screw, Thread in lower part	1 carton of 50 pcs.	1 pallet = 5600 pcs.	2.60 kg	€2.30

MAXI multi-purpose connecting clamp

for connection of round conductors to the
reinforcement and conductive connection of
steel reinforcement with up to Ø 25 mm

Art.Gr.
511



Art. no.	Description	PU	Secondary packaging	Weight per carton	Price per pc.
100148	Galvanised steel , round/round, Round conductor Ø 8-16 mm / Ø 15-25 mm, with mushroom head bolt and protection against twisting	1 carton of 25 pcs.	1 pallet = 1000 pcs.	11.10 kg	€7.15

Stainless steel cross connectors round/round

Universal for flat/flat, flat/round and round/round

Clamping range: round conductor \varnothing 8 + 10 mm, flat conductor up to 30 mm

Art.Gr.
512

Art. no.	Description	PU	Secondary packaging	Weight per carton	Price per pc.
100143	V4A stainless steel , 2-part, round/round universal, heavy duty version, M8 screws	1 carton of 50 pcs.	1 pallet = 3200 pcs.	9.55 kg	€7.55
100145	V4A stainless steel , 2-part, round/round universal, light version, M6 screws	1 carton of 50 pcs.	1 pallet = 3200 pcs.	6.90 kg	€6.30

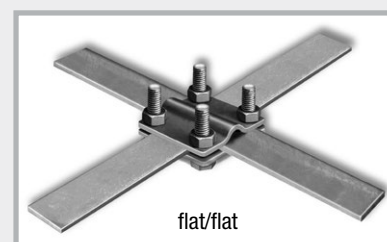
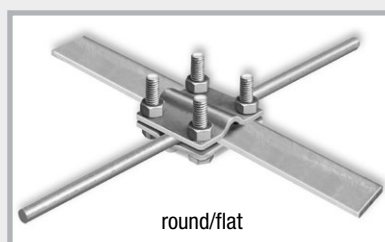
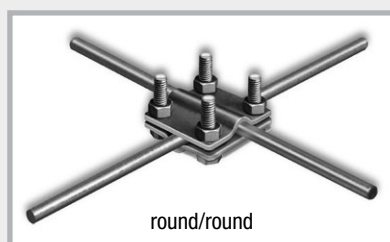

Galvanised cross connectors flat/flat

Clamping range: flat conductor up to 30 mm

Art.Gr.
512

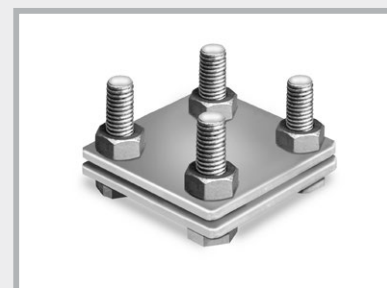

Art. no.	Description	PU	Secondary packaging	Weight per carton	Price per pc.
100100	Galvanised steel , 2-part, flat/flat, heavy duty version, M8 screws	1 carton of 50 pcs.	1 pallet = 3200 pcs.	10.75 kg	€2.95
100106	Galvanised steel , 2-part, flat/flat, light version, M6 screws	1 carton of 50 pcs.	1 pallet = 3200 pcs.	7.65 kg	€1.95

Galvanised cross connectors flat/round

Clamping range:
round conductor \varnothing 8 + 10 mm,
flat conductor up to 30 mm

Art.Gr.
512

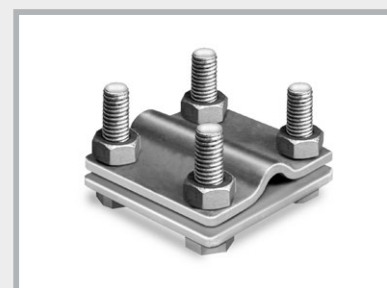

Art. no.	Description	PU	Secondary packaging	Weight per carton	Price per pc.
100115	Galvanised steel , 2-part, flat/round, heavy duty version, M8 screws	1 carton of 50 pcs.	1 pallet = 3200 pcs.	10.80 kg	€2.95
100121	Galvanised steel , 2-part, flat/round, light version, M6 screws	1 carton of 50 pcs.	1 pallet = 3200 pcs.	7.80 kg	€2.10

Galvanised cross connector (for flat conductors up to 30 mm) round/round

Universal for flat/flat, flat/round and round/round

Clamping range: round conductor \varnothing 8 + 10 mm, flat conductor 30 mm

Art.Gr.
512

Art. no.	Description	PU	Secondary packaging	Weight per carton	Price per pc.
100127	Galvanised steel, 2-part, round/round, heavy duty version, M8 screws	1 carton of 50 pcs.	1 pallet = 3200 pcs.	10.95 kg	€3.00
100130	Galvanised steel, 3-part, round/round, heavy duty version, M8 screws With intermediate plate	1 carton of 50 pcs.	1 pallet = 3200 pcs.	14.65 kg	€4.00
100133	Galvanised steel, 2-part, round/round, light version, M6 screws	1 carton of 50 pcs.	1 pallet = 3200 pcs.	8.00 kg	€2.25

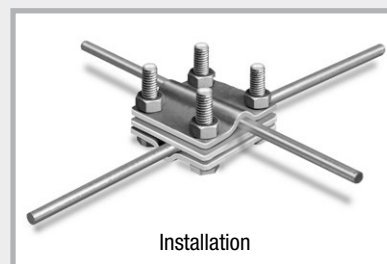
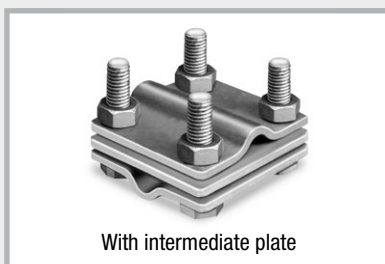
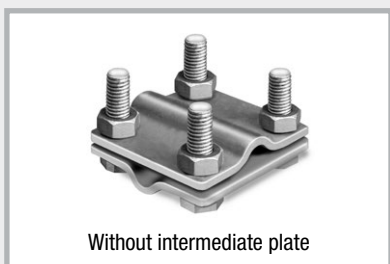

Galvanised cross connector (for flat conductors up to 40 mm) round/round

Universal for flat/flat, flat/round and round/round

Clamping range: round conductor \varnothing 8 + 10 mm, flat conductor 30 + 40 mm

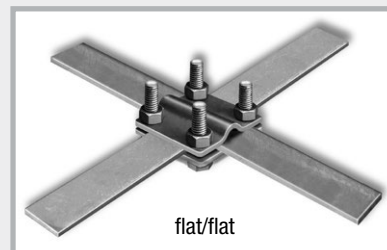
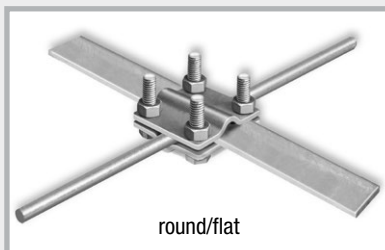
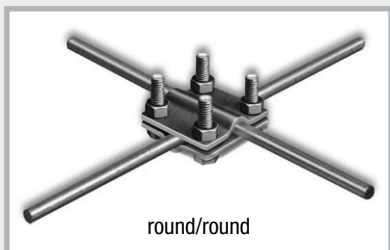

Art.Gr.
512

Art. no.	Description	PU	Secondary packaging	Weight per carton	Price per pc.
100129	Galvanised steel, 2-part, round/round, heavy duty version, M8 screws	1 carton of 50 pcs.	1 pallet = 3200 pcs.	17.60 kg	€4.95





Art.Gr.
518

Connecting clamps for flat conductors

Art. no.	Description	PU	Secondary packaging	Weight per carton	Price per pc.	
100250	Galvanised steel , M10 screw, flat conductors up to 30 mm and constructional steel Ø 6-22 mm	1 carton of 50 pcs.	1 pallet = 4000 pcs.	6.95 kg	€2.20	Art. no. 100250 Art. no. 100251 
100251	Bright steel , M10 screw, flat conductors up to 30 mm and constructional steel Ø 6-22 mm	1 carton of 50 pcs.	1 pallet = 4000 pcs.	6.45 kg	€2.10	
100253	Galvanised steel , M10 screw, flat conductors up to 40 mm and constructional steel Ø 6-22 mm	1 carton of 50 pcs.	1 pallet = 3200 pcs.	6.05 kg	€2.25	Art. no. 100252 Art. no. 100253 
100252	V4A stainless steel , M10 screw flat conductors up to 40 mm and constructional steel Ø 6-22 mm	1 carton of 50 pcs.	1 pallet = 3200 pcs.	5.25 kg	€5.80	

Art.Gr.
518

Connecting clamps for flat and round conductors

Art. no.	Description	PU	Secondary packaging	Weight per carton	Price per pc.	
100255	Galvanised steel , M10 screw, for flat conductors up to 30 mm, Round conductor Ø 8 + 10 mm, Constructional steel Ø 6-22 mm	1 carton of 50 pcs.	1 pallet = 3200 pcs.	9.30 kg	€2.95	Art. no. 100255 Art. no. 100257 
100257	V4A stainless steel , M10 screw, for flat conductors up to 30 mm, Round conductor Ø 8 + 10 mm, Constructional steel 6-22 mm	1 carton of 50 pcs.	1 pallet = 3200 pcs.	8.05 kg	€8.90	
100146	Universal connecting clamp with pressure plate , Galvanised steel , M10 screw, for flat conductors up to 30 mm, Round conductor Ø 8 + 10 mm, Constructional steel Ø 6-22 mm	1 carton of 50 pcs.	1 pallet = 3200 pcs.	7.55 kg	€3.25	Art. no. 100146 Art. no. 100254  Pressure plate
100254	Universal connecting clamp with pressure plate , V4A stainless steel , M10 screw, for flat conductors up to 30 mm, Round conductor Ø 8 + 10 mm, Constructional steel Ø 6-22 mm	1 carton of 50 pcs.	1 pallet = 3200 pcs.	6.40 kg	€7.90	

Art.Gr.
518

Connecting clamps for round conductors

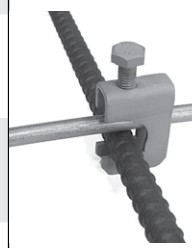
Art. no.	Description	PU	Secondary packaging	Weight per carton	Price per pc.	
100258	Galvanised steel , M10 screw, for round connector Ø 6-10 mm, Constructional steel Ø 6-10 mm	1 carton of 50 pcs.	1 pallet = 4000 pcs.	5.00 kg	€1.60	Art. no. 100258 Art. no. 100259 Art. no. 100260 Art. no. 100261 
100259	Galvanised steel , M10 screw, for round conductors Ø 8 + 10 mm, Constructional steel Ø 6-22 mm	1 carton of 50 pcs.	1 pallet = 3200 pcs.	5.85 kg	€2.30	
100261	Bright steel , M10 screw, for round conductors Ø 8 + 10 mm, Constructional steel Ø 6-22 mm	1 carton of 50 pcs.	1 pallet = 3200 pcs.	5.60 kg	€2.20	
100260	V4A stainless steel , M10 screw, for round conductors Ø 8 + 10 mm, Constructional steel Ø 6-22 mm	1 carton of 50 pcs.	1 pallet = 3200 pcs.	5.10 kg	€5.80	

Double clamps

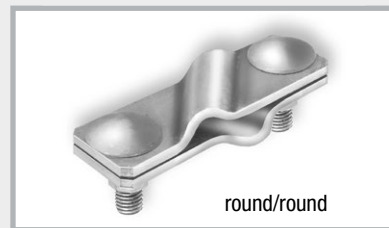
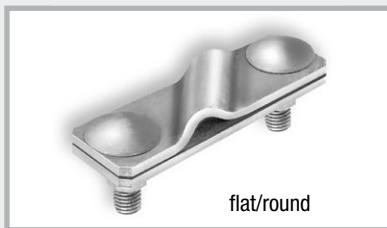
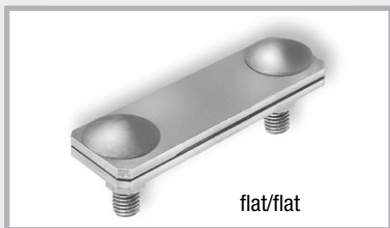

Stainless steel double clamps

for earthing strap up to 40 mm width and round conductors Ø 8 + 10 mm

Art.Gr. 513

Art. no.	Description	PU	Secondary packaging	Weight per carton	Price per pc.
100273	V4A stainless steel, 2-part, flat/flat, heavy duty version, M10 screws	1 carton of 50 pcs.	1 pallet = 3200 pcs.	9.80 kg	€7.20
100279	V4A stainless steel, 2-part, flat/round, heavy duty version, M10 screws	1 carton of 50 pcs.	1 pallet = 3200 pcs.	9.35 kg	€7.20
100282	V2A stainless steel, 2-part, round/round heavy duty version, M10 screws	1 carton of 50 pcs.	1 pallet = 3200 pcs.	9.55 kg	€5.60
100285	V4A stainless steel, 2-part, round/round heavy duty version, M10 screws	1 carton of 50 pcs.	1 pallet = 3200 pcs.	9.35 kg	€7.40

Galvanised double clamps

for earthing strap up to 40 mm width and round conductors Ø 8 + 10 mm

Art.Gr. 513

Art. no.	Description	PU	Secondary packaging	Weight per carton	Price per pc.
100220	Galvanised steel, 2-part, flat/flat, heavy duty version, M10 screws	1 carton of 50 pcs.	1 pallet = 3200 pcs.	12.15 kg	€2.65
100225	Galvanised steel, 2-part, flat/round, heavy duty version, M10 screws	1 carton of 50 pcs.	1 pallet = 3200 pcs.	11.60 kg	€2.65
100230	Galvanised steel, 2-part, round/round, heavy duty version, M10 screws	1 carton of 50 pcs.	1 pallet = 3200 pcs.	11.70 kg	€2.70

Possible clamping connections

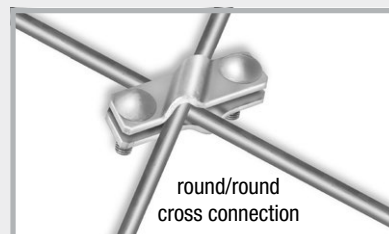
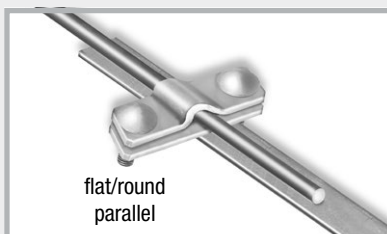
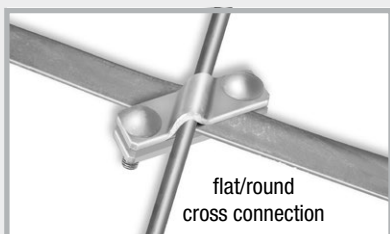
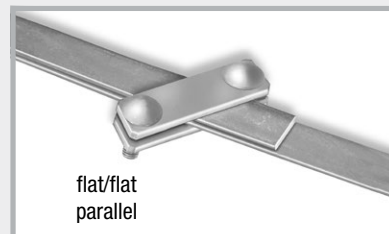
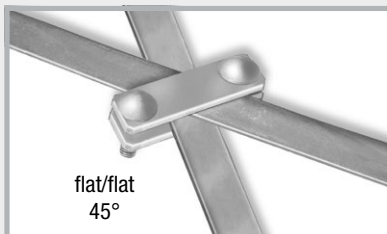
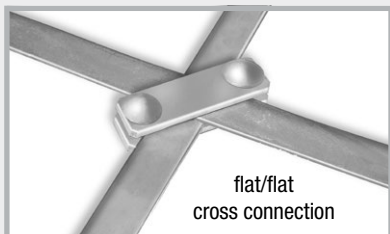

Art.Gr.
514

Single clamps

Art. no.	Description	PU	Secondary packaging	Weight per carton	Price per pc.
100163	Galvanised steel , 1 M10 screw, for flat conductors up to 30 mm and round conductors \varnothing 8+ 10 mm, for T, cross and parallel connections	1 carton of 50 pcs.	1 pallet = 3200 pcs.	6.40 kg	€2.20
100162	V4A stainless steel , 1 M10 screw, for flat conductors up to 30 mm and round conductors \varnothing 8+ 10 mm, for T, cross and parallel connections	1 carton of 50 pcs.	1 pallet = 3200 pcs.	5.25 kg	€6.75

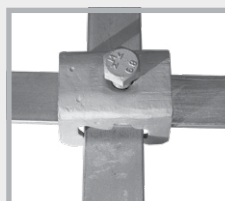
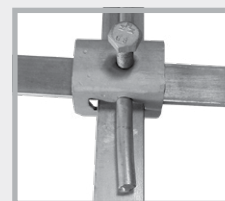

Single clamp

flat/flat
parallel connectionflat/flat
cross connectionflat/round
parallel connectionflat/flat/round
connection

Parallel connectors

Art.Gr.
514

Art. no.	Description	PU	Secondary packaging	Weight per carton	Price per pc.
100240	Galvanised steel , 1 M10 screw, 2-part, for round conductors \varnothing 8 + 10 mm	1 carton of 50 pcs.	1 pallet = 5600 pcs.	7.35 kg	€2.00
100243	V4A stainless steel , 1 M10 screw, 2-part, for round conductors \varnothing 8 + 10 mm	1 carton of 50 pcs.	1 pallet = 5600 pcs.	6.05 kg	€5.95

Wedge connector

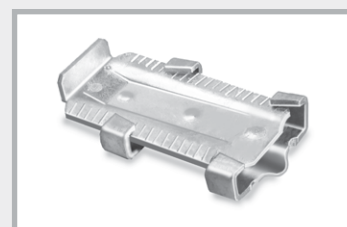
Art.Gr.
514

Art. no.	Description	PU	Secondary packaging	Weight per carton	Price per pc.
100160	Galvanised steel , for round conductors \varnothing 10 mm and flat conductors up to 40 mm, with lock-in position in the wedge	1 carton of 50 pcs.	1 pallet = 3200 pcs.	10.90 kg	€2.40

Fixed earthing terminal M10/M12

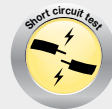

to connect the equipotential bonding conductors to the ring electrode, reinforcement and lightning protection system

Art.Gr. 519



Art. no.	Description	PU	Weight per carton	Price per pc.	
100187	Fixed earthing terminal M10/M12, V4A stainless steel, Ø 80 mm; without axis, with yellow protective cap, connection M10 + M12	1 carton of 10 pcs.	1.60 kg	€13.95	
100202	Fixed earthing terminal M10/M12, V4A stainless steel, Ø 80 mm; with mounted, galvanised axis 200 mm, total length 230 mm, with yellow protective cap	1 carton of 10 pcs.	2.90 kg	€18.40	
NEW! 100204	Fixed earthing terminal M10/M12, V4A stainless steel, Ø 80 mm; with mounted, galvanised axis 120 mm, total length 160 mm, with yellow protective cap	1 carton of 10 pcs.	2.60 kg	€18.35	
NEW! 100203	Fixed earthing terminal M10/M12, V4A Edelstahl, Ø 80 mm; with mounted stainless steel axis 200 mm, total length 230 mm, with yellow protective cap	1 carton of 10 pcs.	2.90 kg	€22.00	
100200	Fixed earthing terminal M10/M12, V4A stainless steel, Ø 80 mm; with mounted A2 multi-purpose connecting clamp, with yellow protective cap	1 carton of 10 pcs.	2.40 kg	€17.45	

Installation

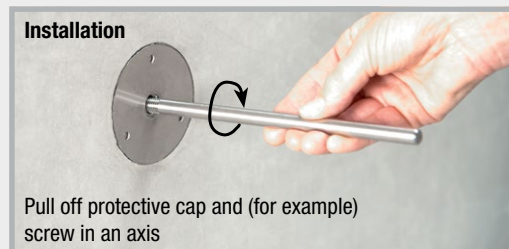
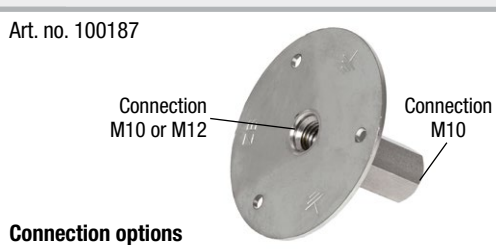

M10 "Solo" axes for fixed earthing terminal M10/M12

Art.Gr. 521

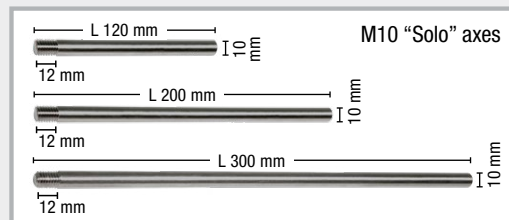

Art. no.	Description	PU	Weight/carton	Price/pc.
NEW! 100256	galvanised, length 120 mm	1 carton of 50 pcs.	3.50 kg	€4.40
100183	galvanised, length 200 mm	1 carton of 50 pcs.	6.00 kg	€4.40
100185	galvanised, length 300 mm	1 carton of 50 pcs.	9.50 kg	€5.65
100184	V4A stainless steel, length 200 mm	1 carton of 50 pcs.	6.00 kg	€8.00
100186	V4A stainless steel, length 300 mm	1 carton of 50 pcs.	9.00 kg	€13.30

M10 "Safe" axes for pressure water-tight fixed earthing terminal M10/M12

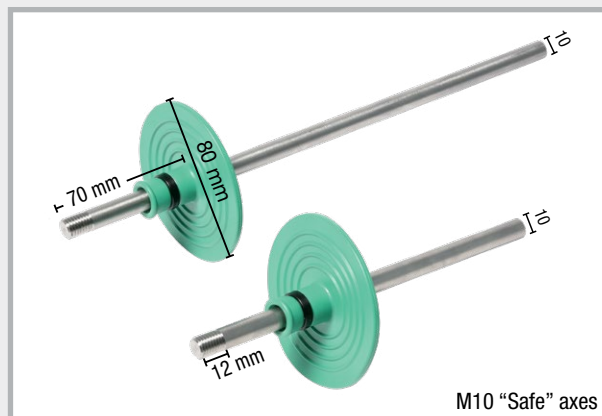
Art.Gr.
521

M10 "Safe" axes

Art. no.	Description	PU	Weight/pc.	Price/pc.
100179	V4A stainless steel, length 200 mm	1 pc.	0.15 kg	€15.90
100180	V4A stainless steel, length 300 mm	1 pc.	0.21 kg	€22.70



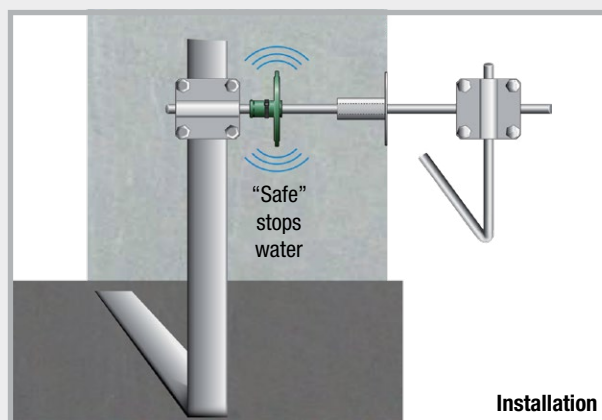

Fixed earthing terminal with "Safe" axis



Installation

Cross clamps for fixed earthing terminals M10/M12

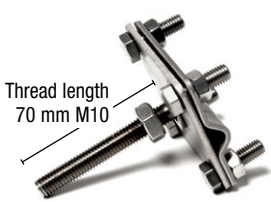
Art.Gr.
522

Art. no.	Description	PU	Weight per carton	Price per pc.	
100188	Cross clamp for fixed earthing terminal M10/M12, galvanised, M10 thread, Thread length 70 mm, for round conductors Ø 8 + 10 mm and flat conductors up to 40 mm	1 carton of 10 pcs.	3.80 kg	€12.15	Art. no. 100188 Art. no. 100189 
100189	Cross clamp for fixed earthing terminal M10/M12, V4A stainless steel, M10 thread, Thread length 70 mm, for round conductors Ø 8 + 10 mm and flat conductors up to 40 mm	1 carton of 10 pcs.	3.20 kg	€24.50	Installation Fixed earthing terminal with screwed in cross clamp. Round and flat conductors can be connected. 

M10 "Safe" wall bushings with pre-assembled fixed earthing terminals

The M10 wall bushings are pre-assembled and supplied in the exact wall thickness. Time-consuming adjustments are not necessary.

Fixed earthing terminal: V4A stainless steel, connection axes 10 mm: stainless steel

Art.Gr. 520

Wall thickness	Art. no.	Weight/pc.	Price/pc.
200 mm	100394	0.42 kg	€49.20
240 mm	100396	0.45 kg	€50.80
250 mm	100398	0.45 kg	€50.90
300 mm	100400	0.48 kg	€52.15



M10 connection axis "Safe" for wall bushings

Stainless steel, diameter 10 mm, M10 thread at both ends, length of thread 12 mm

Art.Gr. 521

Wall thickness	Art. no.	Weight/pc.	Price/pc.
200 mm	100360	0.10 kg	€15.90
240 mm	100365	0.13 kg	€18.00
250 mm	100370	0.13 kg	€18.20
300 mm	100375	0.16 kg	€19.90



NEW! Wall bushing, flexible



Flexible wall bushing M10 for vertically and horizontally offset positioning of earthing connections, fixed earthing terminal in V4A stainless steel, fine-wired copper cable 25 mm²

Art.Gr. 535

Art. no.	Description	PU	Weight per pc.	Price per pc.
100660	Wall bushing, flexible 600 mm, 2 x fixed earthing terminal with connecting clamp 1 x sheathed copper cable, length 600 mm	1 pc.	0.54 kg	€59.00
100662	Wall bushing, flexible 1200 mm, 2 x fixed earthing terminal with connecting clamp 1 x sheathed copper cable, length 1200 mm	1 pc.	0.71 kg	€69.00
100670	Wall bushing, flexible 600 mm "Safe", sealed pressure water-tight with RONDO EFP, 2 x fixed earthing terminal with connecting clamp and RONDO EFP 1 x sheathed copper cable, length 600 mm	1 pc.	0.62 kg	€72.00
100672	Wall bushing, flexible 1200 mm "Safe", sealed pressure water-tight with RONDO EFP, 2 x fixed earthing terminal with connecting clamp and RONDO EFP 1 x sheathed copper cable, length 1200 mm	1 pc.	0.79 kg	€82.00

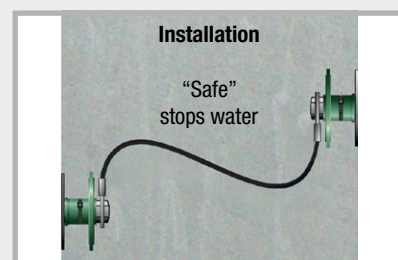
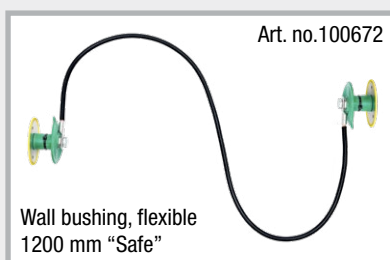
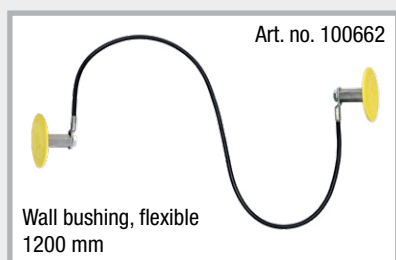

1 HYDROPHILIC WATERSTOPS
2 JOINT SHEET METALS
3 INJECTION HOSES CONSTRUCTION CHEMISTRY
4 SERVICE DUCTS
5 LIGHTNING PROTECTION
6 FORMWORK ACCESSORIES

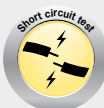
NEW! Connection set, flexible

as a flexible connection to earthing systems or reinforcement bars,
with connecting clamps, ready assembled and mounted,
fixed earthing terminal M10/M12 in V4A stainless steel, fine-wired copper cable 25 mm²

Art.Gr.
535

Art. no.	Description	PU	Weight/pc.	Price/pc.
100663	Connection set, flexible 600 mm with flexible connecting clamp, 1 x connecting clamp (Art. no. 100251) 1 x fixed earthing terminal M10/M12 1 x sheathed copper cable, length 600 mm	1 pc.	0.31 kg	€50.00
100664	Connection set, flexible 1200 mm with flexible connecting clamp, 1 x connecting clamp (Art. no. 100251) 1 x fixed earthing terminal M10/M12 1 x sheathed copper cable, length 1200 mm	1 pc.	0.48 kg	€60.00

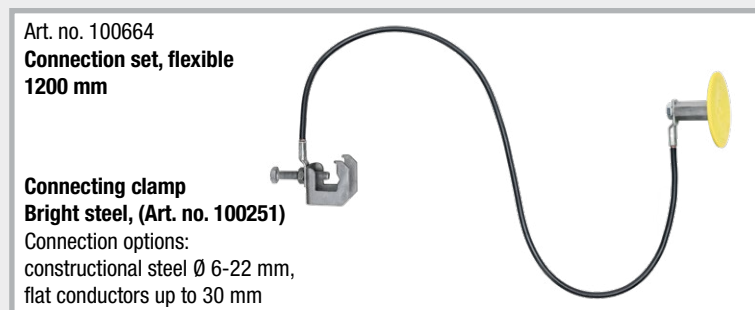
**Fixed earthing terminal M12**

to connect the equipotential bonding conductors
to the ring earth electrode, reinforcement and
lightning protection system

Art.Gr.
523

Art. no.	Description	PU	Weight per carton	Price per pc.	
100300	Fixed earthing terminal M12, V4A stainless steel, with yellow protective cap, Connection M12	1 carton of 10 pcs.	2.00 kg	€24.50	
100304	Fixed earthing terminal M12 "Safe" with yellow protective cap and waterstop, Connection M12	1 carton of 10 pcs.	2.40 kg	€33.15	
100308	Connecting plate 40 x 4 mm, incl. screw M12 x 25	1 carton of 10 pcs.	1.90 kg	€5.00	
100312	Fixed earthing terminal M12 with connecting plate and yellow protective cap, Connection M12	1 carton of 10 pcs.	3.90 kg	€29.50	

M12 "Solo" axes for fixed earthing terminal

Art.Gr. 524

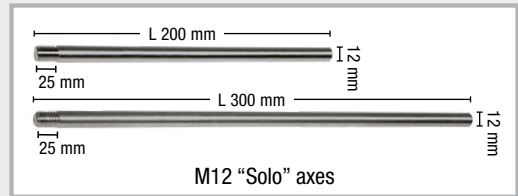

Art. no.	Description	PU	Weight/carton	Price/pc.
101174	V4A stainless steel, length 200 mm	1 carton of 50 pcs.	9.00 kg	€11.10
101176	V4A stainless steel, length 300 mm	1 carton of 50 pcs.	13.00 kg	€13.50

Cross clamps for fixed earthing terminals M12

Art.Gr. 525

Art. no.	Description	PU	Weight/carton	Price/pc.
100460	Cross clamp for fixed earthing terminal M12, galvanised, M12 thread, thread length 70 mm, for round conductors Ø 8 + 10 mm and flat conductors up to 40 mm	1 carton of 10 pcs.	4.20 kg	€13.90
100462	Cross clamp for fixed earthing terminal M12, V4A stainless steel, M12 thread, thread length 70 mm, for round conductors Ø 8 + 10 mm and flat conductors up to 40 mm	1 carton of 10 pcs.	3.45 kg	€21.10
100464	Cross clamp for fixed earthing terminal M12, V4A stainless steel M12 thread, thread length 200 mm, for round conductors Ø 8 + 10 mm and flat conductors up to 40 mm	1 carton of 10 pcs.	4.50 kg	€28.70

Art. no. 100460 + 100462

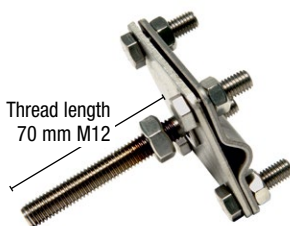

Art. no. 100464

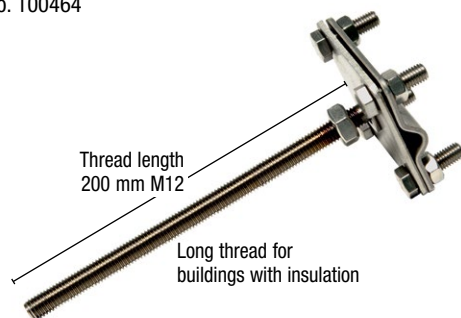

NEW! M12 wall bushings

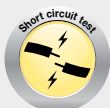

The M12 wall bushings have a solid 25 mm conductive core and are pre-assembled and supplied in the exact wall thickness.

Time-consuming adjustments are not necessary.

Art.Gr. 526



M12 wall bushings
Type solo

Water pressure-tight wall bushing; M12 threaded connection on both sides; incl. nail adapter for fastening to the formwork



M12 wall bushings
Type connect

Water pressure-tight wall bushing; M12 threaded connection on both sides with additional connection plate for concrete-laid earthing conductors; incl. nail adapter for fastening to the formwork



M12 wall bushings
Type iso

Water pressure-tight, insulated wall bushing; M12 threaded connection on both sides; incl. nail adapter for fastening to the formwork

Wall thickness mm	M12 wall bushings								
	Type solo			Type connect			Type iso		
	Art. no.	Weight per pc.	Price per pc.	Art. no.	Weight per pc.	Price per pc.	Art. no.	Weight per pc.	Price per pc.
70	100366	0.42 kg	€60.00	100366C	0.52 kg	€66.00	100366I	0.52 kg	€68.00
80	100367	0.47 kg	€64.00	100367C	0.57 kg	€70.00	100367I	0.57 kg	€72.00
100	100368	0.52 kg	€72.00	100368C	0.62 kg	€79.00	100368I	0.62 kg	€80.00
120	100369	0.60 kg	€74.00	100369C	0.70 kg	€80.00	100369I	0.70 kg	€82.00
150	100371	0.72 kg	€76.00	100371C	0.82 kg	€83.00	100371I	0.82 kg	€85.00
200	100372	0.93 kg	€79.00	100372C	1.03 kg	€87.00	100372I	1.03 kg	€90.00
240	100373	1.09 kg	€82.00	100373C	1.19 kg	€90.00	100373I	1.19 kg	€94.00
250	100374	1.14 kg	€83.00	100374C	1.24 kg	€91.00	100374I	1.24 kg	€95.00
300	100376	1.34 kg	€87.00	100376C	1.44 kg	€95.00	100376I	1.44 kg	€100.00

Art. no.	Description	PU	Weight	Price/pc.
100377	Cross clamp for fixed earthing terminal M12, V4A stainless steel, M12 thread, thread length 70 mm, System component for wall bushings solo, connect and iso	1 pc.	0.30 kg	€39.00

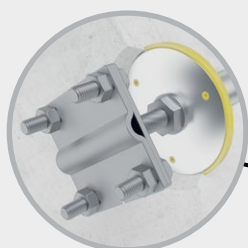

Cross clamp connection option for M12 wall bushings

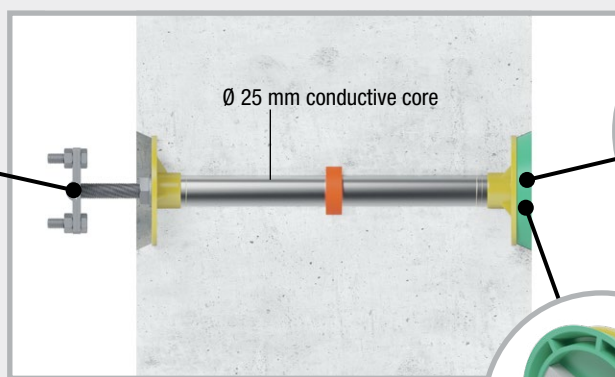

Installation situation water-impermeable concrete wall

Ø 25 mm conductive core

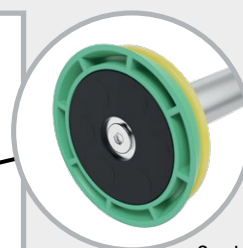



Can be combined with FIX magnet for fastening to steel formwork or formwork tables in the precast plant (art. No. 091410), not included in the scope of delivery



Standard nail adapter for fastening to wooden or plastic formwork panels

Fixed earthing terminal M16 and accessories

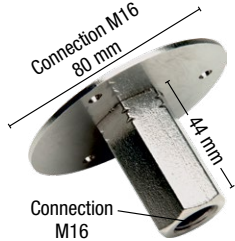

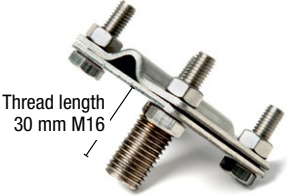

to connect the equipotential bonding conductors to the foundation earth electrode, reinforcement and lightning protection system

Art. no.	Description	PU	Weight per pc.	Price per pc.	
100455	Fixed earthing terminal M16, V4A stainless steel, without axis, with yellow protective cap, Connection M16 Art.Gr. 527	1 carton of 10 pcs.	1.70 kg per carton	€23.90	
100461	Fixed earthing terminal M16, V4A stainless steel, with flexible connection conductor, Connection conductor CU/SN 95 mm², Conductor length 400 mm Art.Gr. 527	1 pc.	0.66 kg	€99.00	
100458	Cross clamp for fixed earthing terminal M16, VA4 stainless steel, M16 thread, Thread length 30 mm, for round conductors Ø 8 + 10 mm and flat conductors up to 40 mm Art.Gr. 528	1 carton of 10 pcs.	3.10 kg per carton	€24.00	

Wall bushings (N)

For subsequent installation of earthing conductors in borehole Ø 14 mm or distance tube. Threaded rod with fixed/loose flange made of V4A stainless steel, connecting clamp and nuts made of galvanised steel.

Art.Gr. 534

Wall thicknesses	Art. no.	PU	Weight per pc.	Price per set	
100-300 mm 	100310	1 set	0.66 kg	€47.00	Inside connection options: Round conductors with pre-installed multi-purpose connecting clamp; flat conductors with double clamp page 160: This clamp can be installed in place of the multi-purpose connecting clamp at the construction site. Inside connection  Outside connection M12  Outside connection options: Cross clamp M12, page 166 M12 "Solo" axes page 166
300-500 mm 	100315	1 set	0.80 kg	€49.00	
Description	Art. no.	PU	Weight/pc.	Price/pc.	
Connecting-clamp for wall bushing (N), galvanised Connection: Threaded rod on multi-purpose connecting clamp, M10 screw, for round conductors 8-10 mm, with borehole Ø 13 mm	100181	1 pc.	0.14 kg	€5.15	

Gasket insert for round conductors, core drill hole 50 mm

Pressure water-tight lead-in with the MASTER-RING gasket insert

Art.Gr. 440

Art. no.	Description	PU	Weight/pc.	Price/pc.	
120080	Gasket insert for round conductors 8 + 10 mm, Core drill hole Ø 50 mm, Medium pipe 6-12 mm	1 pc.	0.38 kg	€54.00	 Discount according to product group 4

1 HYDROPHILIC WATERSTOPS
2 JOINT SHEET METALS
3 INJECTION HOSES CONSTRUCTION CHEMISTRY
4 SERVICE DUCTS
5 LIGHTNING PROTECTION
6 FORMWORK ACCESSORIES

Accessories for fixed earthing terminal

 Art.Gr.
529

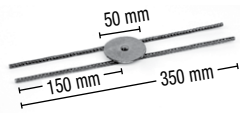
Art. no.	Description	PU	Weight per pc.	Price per pc.	
100198	Plastic foam for fixed earthing terminal , self-adhesive on one side, Ø 76 mm, thickness 20 mm	1 bag of 10 pcs.	0.08 kg	€1.50	
100196	Fixing spider for fixed earthing terminal , steel/bright	1 pc.	0.12 kg	€9.70	

**Installation**

1

Remove protective cap of fixed earthing terminal



2

Stick on plastic foam

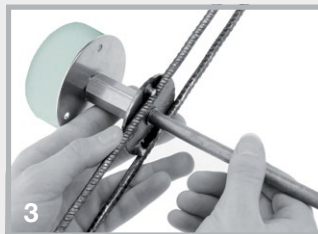

3

Screw axis through the fixing spider and fasten fixed earthing terminal

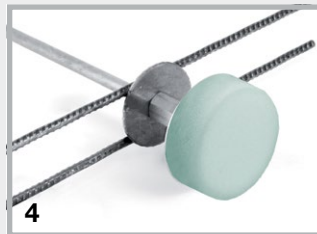

4

Installation complete

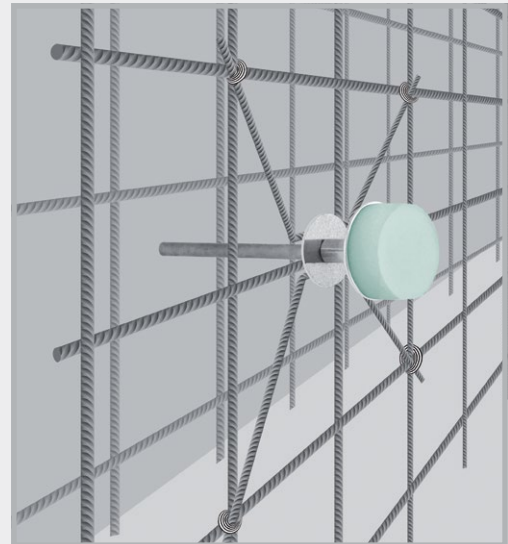

Fixed earthing terminal with fixing spider on the reinforcement



FIX formwork aid

Fastening systems

for fixed earthing terminals in precast concrete plants

Fastening to steel formworks using the FIX Magnet

 Art.Gr.
420

Art. no.	Description	PU	Weight/pc.	Price/pc.	
091410	FIX Magnet for formwork aid Power Magnet for all FIX formwork aids, incl. screw and wing nut	25 pcs.	0.14 kg	€32.80	
090804	FIX EFP formwork aid for fixed earthing terminals M10/12 and M12 Cone height 11 mm	25 pcs.	0.03 kg	€5.00 Discount according to product group 4	

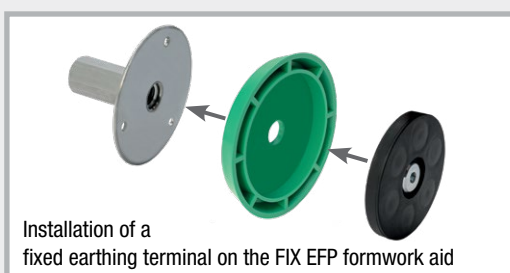

Installation of a fixed earthing terminal on the FIX EFP formwork aid

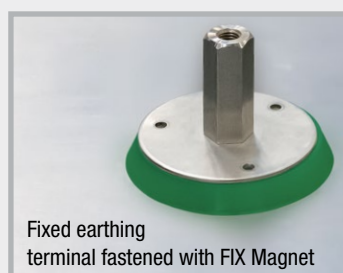

Fixed earthing terminal fastened with FIX Magnet



Option for connection to the fixed earthing terminal, for example with axis and clamp

Terminal lugs

Round conductor rods, bevelled

Art.Gr.
531

Art. no.	Description	Length	PU	Weight per bundle	Price per pc.
100555	V4A stainless steel round conductor Ø 10 mm	1.50 m	1 bundle of 10 pcs.	9.40 kg	€15.00
100560	V4A stainless steel round conductor Ø 10 mm	2.00 m	1 bundle of 10 pcs.	12.50 kg	€19.50
100565	V4A stainless steel round conductor Ø 10 mm	2.50 m	1 bundle of 10 pcs.	15.70 kg	€26.20
100570	V4A stainless steel round conductor Ø 10 mm	3.00 m	1 bundle of 10 pcs.	18.60 kg	€30.50



RONDO Standard

Sealing collars for lightning protection wire and earthing strap



RONDO sealing collars form pressure water-tight seals for lightning protection wires and earthing straps passing through concrete walls, floor slabs and shafts.

Art.Gr.
400

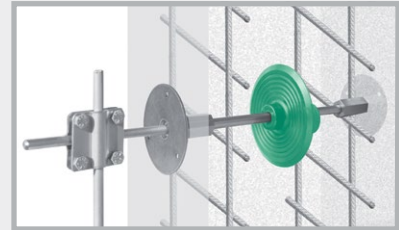

Art. no.	Description	PU	Secondary packaging	Weight per pc.	Price per pc.
090890	RONDO RO 10, for lightning protection conductors Ø 8 + 10 mm	1 pc.	1 carton of 100 pcs.	0.12 kg	€21.20
090892	RONDO RO flat, for earthing strap 30x3.5 + 30x3.0 mm	1 pc.		0.18 kg	€23.40
090988	RONDO EFP, for hexagon fixed earthing terminal	1 pc.	1 bag of 25 pcs.	0.04 kg	€7.00



The sealing collars are supplied with fastening straps, ready for installation

Accessories

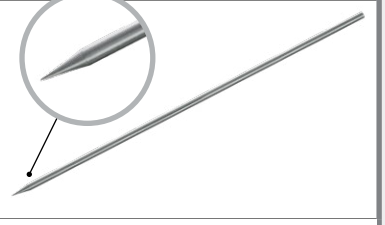
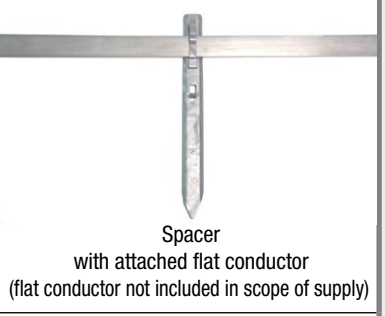
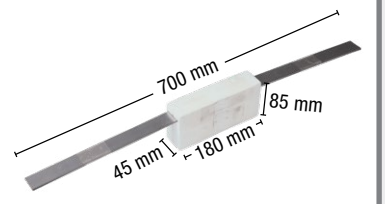
Art. no.	Description	PU	Weight per pc.	Price per pc.	
100165	Profiled earth rod, Length: 1.5 m, galvanised, cross profile 50 x 50 mm, with terminal lug	1 pc.	3.90 kg	€23.50	
100206	Earth rod for the construction site, Length 1.2 m, Ø 20 mm, galvanised, with impact tip, Connection with clamps from the earth rod range	1 pc.	2.86 kg	€15.20	
100170	Spacer for foundation earth electrode, galvanised, for round connector Ø 8-10 mm, earthing strap 30 x 3.5 mm, length 280 mm, installation spacing 1-1.5 m	1 carton of 100 pcs.	9.80 kg per carton	€1.90	 Spacer with attached flat conductor (flat conductor not included in scope of supply)
100176	Expansion strip with polystyrene body, V2A stainless steel, for routing of foundation earth electrode through expansion joints	1 pc.	0.70 kg	€51.90	

Anti-corrosive tapes

for wrapping of overground and underground connections

Art. no.	Description	PU	Weight per roll	Price per roll	
100190	Anti-corrosive tapes, Roll length 10 m certified by DVGW Size: 1.5 x 50 mm	1 carton of 40 rolls	0.71 kg	€10.65	
100193	Size: 1.5 x 100 mm	1 carton of 20 rolls	1.20 kg	€21.30	

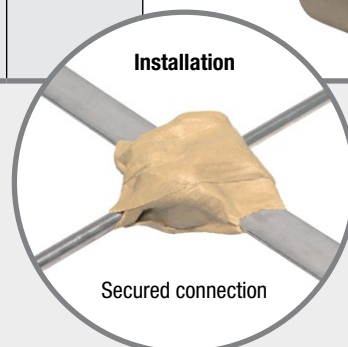

1 HYDROPHILIC WATERSTOPS
2 JOINT SHEET METALS
3 INJECTION HOSES CONSTRUCTION CHEMISTRY
4 SERVICE DUCTS
5 LIGHTNING PROTECTION
6 FORMWORK ACCESSORIES

Earth rod

for use in earthing systems

Art.Gr.
533

Art. no.	Design	PU	Weight per pc.	Price per pc.	
100205	Earth rod for the installation of earthing systems, galvanised, Length 1500 mm, Ø 20 mm	1 pc.	3.60 kg	€23.60	
100210	Earth rod for the installation of earthing systems, V4A stainless steel, Length 1500 mm, Ø 20 mm	1 pc.	3.70 kg	€92.90	 The earth rods have a drilled hole on one side and a pin on the other. This produces a self-closing coupling.
100215	Impact tip for driving in the first earth rod, bright steel	1 pc.	0.04 kg	€6.00	
100216	Drive-in aid for earth rod, bright steel	1 pc.	0.48 kg	€11.00	
100218	Connecting clamp for earth rod, galvanised, heavy duty version with M10 screws for round conductors Ø 8 + 10 mm and flat conductors up to 40 mm	1 pc.	0.38 kg	€5.00	
100217	Connecting clamp for earth rod V4A stainless steel, heavy duty version with M10 screws for round conductors Ø 8 + 10 mm and flat conductors up to 40 mm	1 pc.	0.30 kg	€14.00	 Connecting clamp installed

Basic principles of the installation of lightning protection conductors and connectors

FOUNDATION EARTH ELECTRODE

Installation location: In the concrete of the foundation and floor slab with minimum 5 cm concrete cover on all sides

Material: Galvanised or non-galvanised steel as flat conductor 30 x 3.5 mm or round conductor DN 10 mm

CONNECTION PARTS ON FOUNDATION EARTH ELECTRODE

Installation location: In subsoil

Material: A4 stainless steel material grades 1.4401, 1.4404, 1.4571
Flat conductor 30 x 3.5 mm or round conductor DN 10 mm

RING EARTH ELECTRODE AND CONNECTION PARTS ON RING EARTH ELECTRODE

Installation location: Outside the foundation in the subsoil

Material: A4 stainless steel material grades 1.4401, 1.4404, 1.4571 as
30 x 3.5 mm flat conductor or DN 10 mm round conductor
Galvanised material is not permitted in this area

CONNECTORS

Installation location: In subsoil, connector made of A4 stainless steel, galvanised in foundation

Description: Wedge connectors are not permitted: unless installed in non-vibrated concrete
4 x M6 screws above ground only and for arrester lines and down conductors
4 x M8 or 2 x M10 screws and M10 multi-purpose connecting clamp for use in the following areas: subsoil, concrete, above ground, down conductors and arrester lines.

DIN STANDARDS DIN EN 62561-1 and 62561-2

COSTS The cost of stainless steel round conductors is up to 33% less than stainless steel flat conductors. The round conductor, which can be installed as an alternative to the flat conductor, is easier to handle and therefore has a significantly higher workability.